

Thomas Keating and QMC Instruments: Space Capabilities

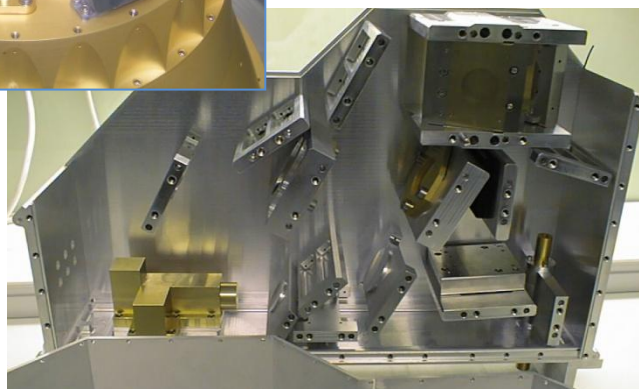

Thomas Keating Ltd

Station Mills, Daux Road, Billingshurst, West Sussex, RH14 9SH, United Kingdom
Phone +44 (0)1403 782045, Fax +44 (0)1403 785464, www.terahertz.co.uk

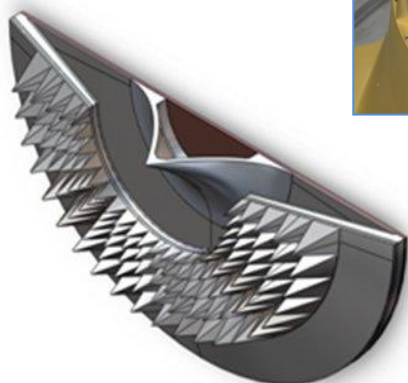
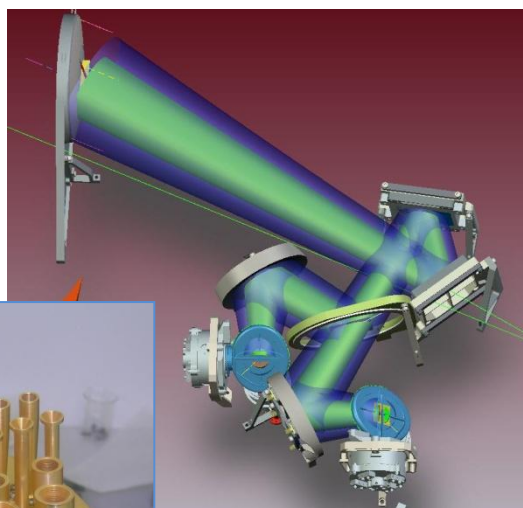
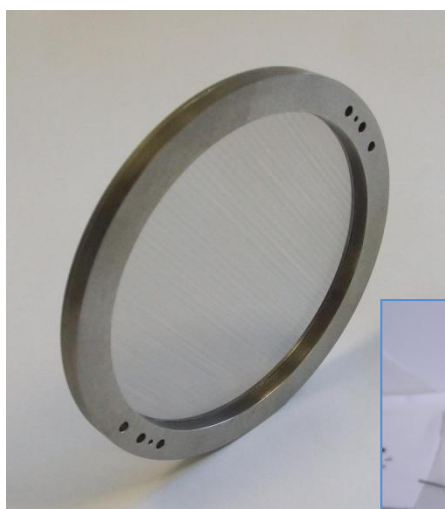

1 Introduction

Thomas Keating Ltd. (TK) and its sister company QMC Instruments have previously developed quasi-optic hardware that is flying or (in the case of EarthCARE and STEAM-R) is being developed for launch on space observation mission. Projects include:

- AMSU-B (UK Met Office)
- MHS and its derivatives (BAe Systems and its successor companies)
- JEM/SMILES (JAXA)
- Planck HFI (ESA)
- ATMS (Northrop-Grumman/NOAA/NASA)
- CPR on EarthCARE (Astrium/JAXA)
- MIRO on Rosetta (JPL)
- ODIN(SSC).
- STEAM-R (SSC/Omnysis)

We manufacture a wide range of quasi-optic (QO) components for these missions, including mirrors, polarising wire grids, dichroics and absorbers, and may well have flown more high frequency corrugated horns than any other supplier through our work on the High Frequency Instrument on Planck.

The performance of high frequency horns can match predictions to very low levels. Our ability to match theory and measurement to below -50 dB at high frequencies strongly demonstrates our ability to design, make and measure the horns needed for satellite instruments.

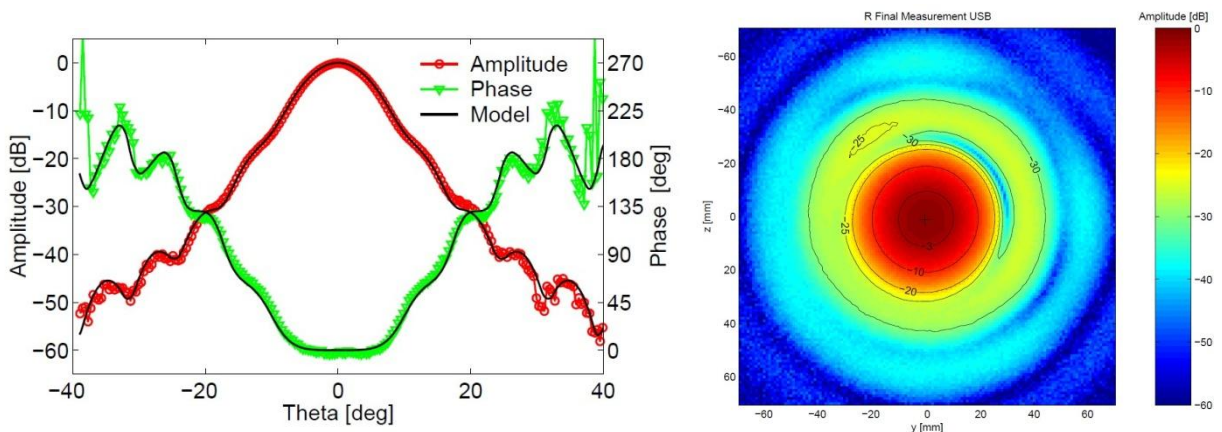

This figure shows the measured and simulated amplitude and phase of the JEM/SMILES feed horn at 640 GHz (left) and planar near-field measurement of the complete JEM/SMILES ambient temperature optics at 650 GHz (right).

While not strictly a space mission, for the Japanese National Astronomical Observatory we are making the Band 10 corrugated feed horns (around 70 in total), for the Atacama Large Millimetre Array Telescope (ALMA). These horns operate from 780 to 950 GHz, and were the supplier of a similar number of Ambient and Hot Load Calibration Target pairs, to calibrate the telescope's 66 receivers.

The experience described in this note demonstrates our ability to fulfil the technical and programmatic requirements of the projects. We remain committed, both commercially and scientifically, to millimetre- and submillimetre-wave quasi-optical hardware systems.

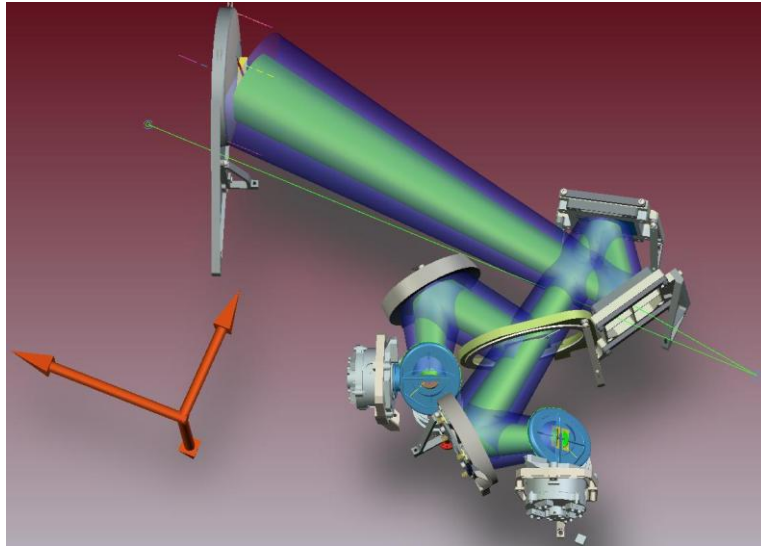

EarthCARE Cloud Pulsed 94 GHz Radar optics: CAD model using the Thomas Keating Ltd. internally-developed Gaussian Beam Mode 3D software engine.

2 Company Background

The commercial origins of Thomas Keating Ltd. stretch back to the 18th Century and the company has been making high precision tooling, such as gauges, injection moulds and press tools for well over seventy years. We produce such components for the medical, aerospace, motorsport and packaging. Industries

The scientific instruments side of the business, developed over the last thirty years, draws on our tool-making skills. We design and develop quasi-optical systems and subsystems operating in the millimetre and submillimetre regime. These systems have been applied to a variety of applications including atmospheric remote sensing, plasma-fusion diagnostics, materials characterisation, cosmology, astronomy and electron spin resonance spectroscopy.

Thomas Keating Ltd's sister company – QMC Instruments Ltd. – based in Cardiff and connected with the Astrophysics Instrumentation Group of Cardiff University. The two companies have a combined turnover in the region of 5M Euros and employ forty people. The businesses are financially strong, profitable, and have no borrowings.

In 2012 Thomas Keating Ltd. received a Queen's Award for Enterprise, a very rare distinction.



Left: corrugated feed horn array designed and manufactured for the High Frequency Instrument on Planck – ESA's cosmic microwave background surveyor. Right: a quasi-optical multiplexer separating 22, 43, 89 and 123 GHz bands, designed and built for the Korean VLBI astronomy Network.

As mentioned above, our space-borne work has included optical components for the AMSU-B water vapour radiometers and their derivative projects, subsystems for JAXA's BrO monitoring limb-sounder JEM SMILES, and the High Frequency Instrument feeds for the Planck Cosmic Microwave Background satellite launched in May 2009. We are currently developing the multiplexer for the 94 GHz pulsed cloud profiling radar on EarthCARE, for JAXA, acting as a subcontractor to Astrium (Germany).

3 Reference Projects

3.1 Quasi-optic networks

JEM/SMILES

JEM/SMILES was a 640 GHz limb-sounding instrument of the Japanese Space Exploration Agency (JAXA) placed onboard the International Space Station. The corrugated feed horns and the Ambient Temperature Optics module with corrugated back-to-back horns (BBH) and a quasi-optical single sideband filter (fixed tuned and temperature stable) were designed and manufactured at TK and tested at the Institute of Applied Physics (IAP) in Bern.

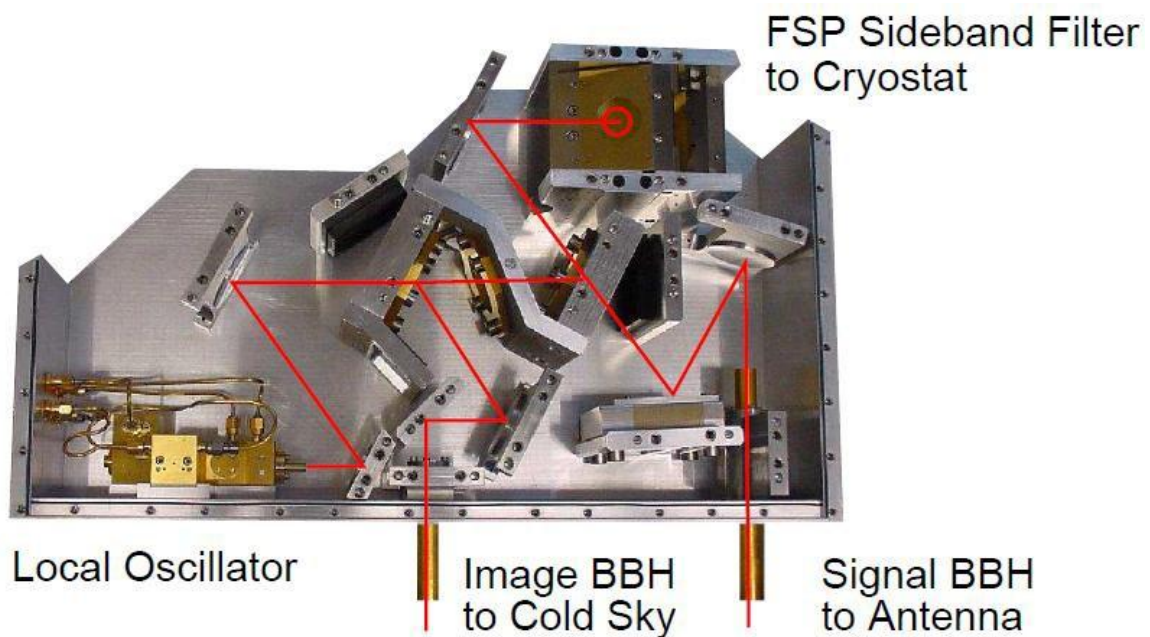

The above figure shows the JEM/SMILES ambient temperature optics. At the top is the Inatani variant of a Martin-Puplett Interferometer, providing the Single Sideband rejection (the upper sideband is placed in one polarization and lower sideband in the other). All of the optics was positioned by direct machining – no adjustment was required.

Cloud Pulsed Radar on EarthCARE

We are currently developing the multiplexer for the 94 GHz pulsed cloud profiling radar on EarthCARE, for JAXA, acting as a subcontractor to Astrium (Germany).



The photograph (courtesy of Astrium) above shows the optics for the 94 GHz CPR functional model. TK designed the optics and manufactured all of the optical components, including the corrugated feedhorns.

The photograph on the left shows the CMM measurement of an evanescent hole for power

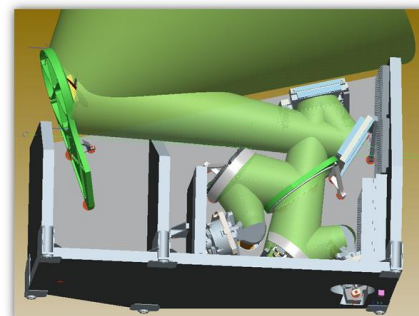
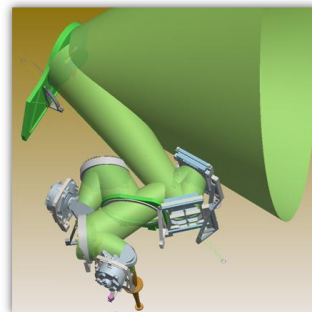
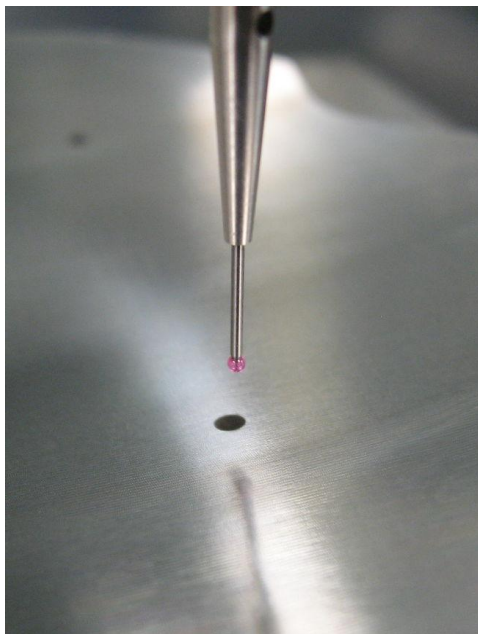

measurement at a curved mirror. The image on the right shows the CAD model using the TK Gaussian Beam Mode 3D Engine.

3.2 Feed horns

Planck HFI

The feed cluster for the High Frequency Instrument on Planck, operating from 100 to 950 GHz, was designed in conjunction with colleagues at Cardiff University.

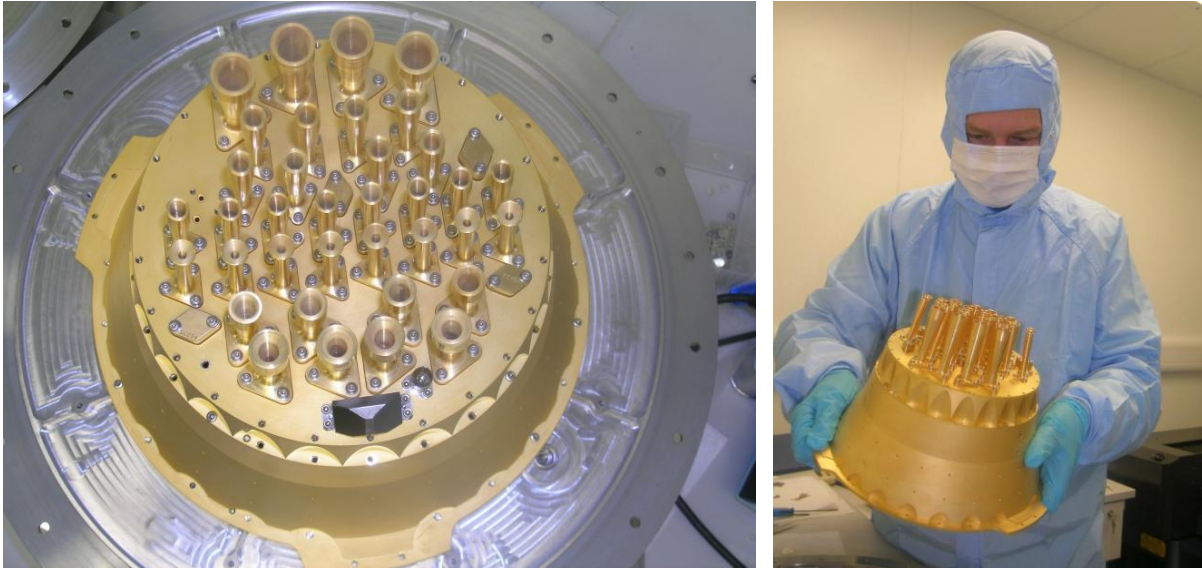

The FPA of the High Frequency Instrument on Planck that performed flawlessly at L2.

For each horn visible in the photographs there are two further horns inside the instrument. This design was used in combination with dichroics from QMC Instruments to enable frequency selection.

Ultra-Gaussian feed horns

We have recently developed Ultra-Gaussian feed horns with the University of St. Andrews. These simplify and improve the optical design of many QO systems. The profile of the corrugations in these horns are configured to reduce side-lobes to the -40dB level, thereby reducing internal optics truncation and improving antenna efficiency.

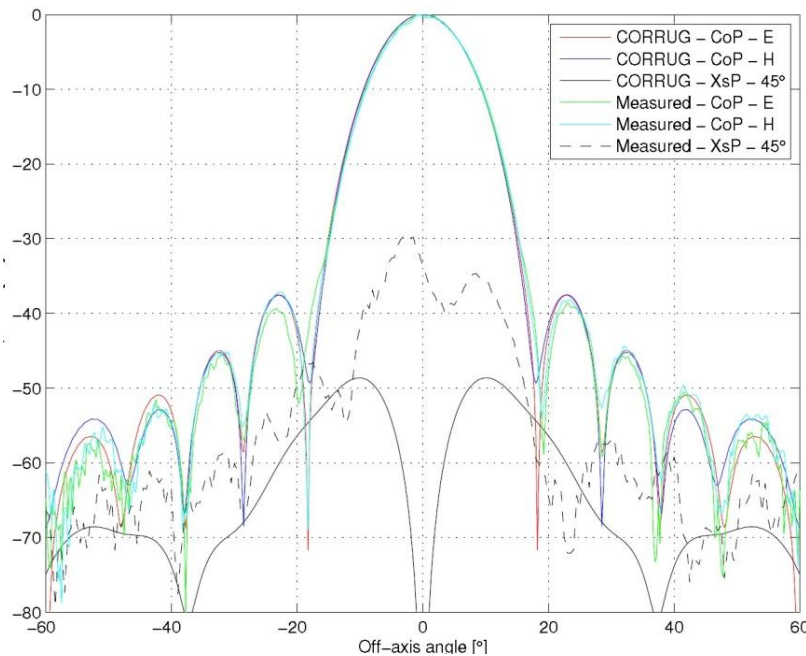

TK designed and manufactured Ultra-Gaussian horn pattern for the STEAM-R project, measured by the IAP at 340 GHz. Note the sidelobes start at just above -40dB . (The higher X-polar signal is – in part – a measurement artefact.)

We have developed both the techniques and – equally importantly – the Product Assurance procedures to provide horns to many space agencies, including ESA, JAXA and NOAA/NASA, for frequencies up to 950 GHz.

3.3 Mirrors

STEAM-R

TK is working with IAP on the focal plane array optics of STEAM-R, which is a 340GHz multi-beam (“push boom”) limb sounding instrument, currently under development by Sweden. The figures below show the monolithically machined facet reflectors of the array under test and an example of the beam pattern measurements at IAP Bern. The CMM and the electrical measurements both confirmed that a surface and alignment accuracy of 4 μm RMS has been achieved.

Other components of the STEAM-R focal plane array breadboard are a polarising wire grid (not shown here) and the design and manufacture of optimised Ultra-Gaussian corrugated feed.

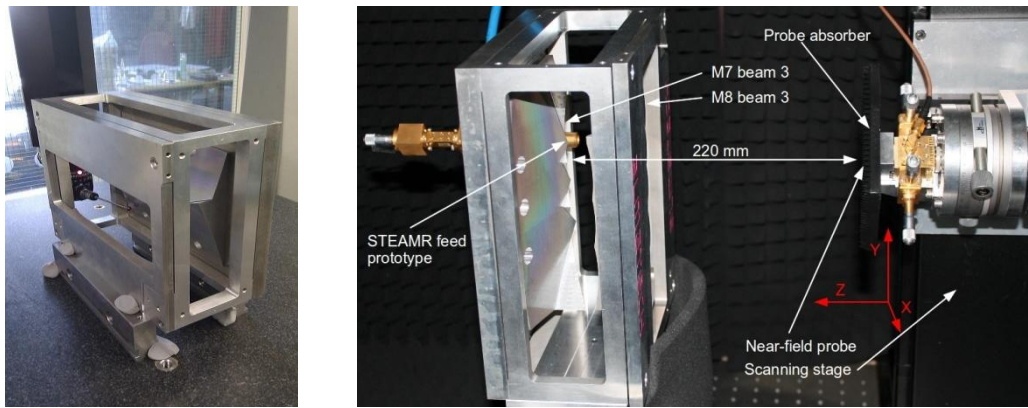

The photographs above show the STEAM-R focal plane under mechanical testing on TKs CMM (left) and in the antenna test range at IAP (right).

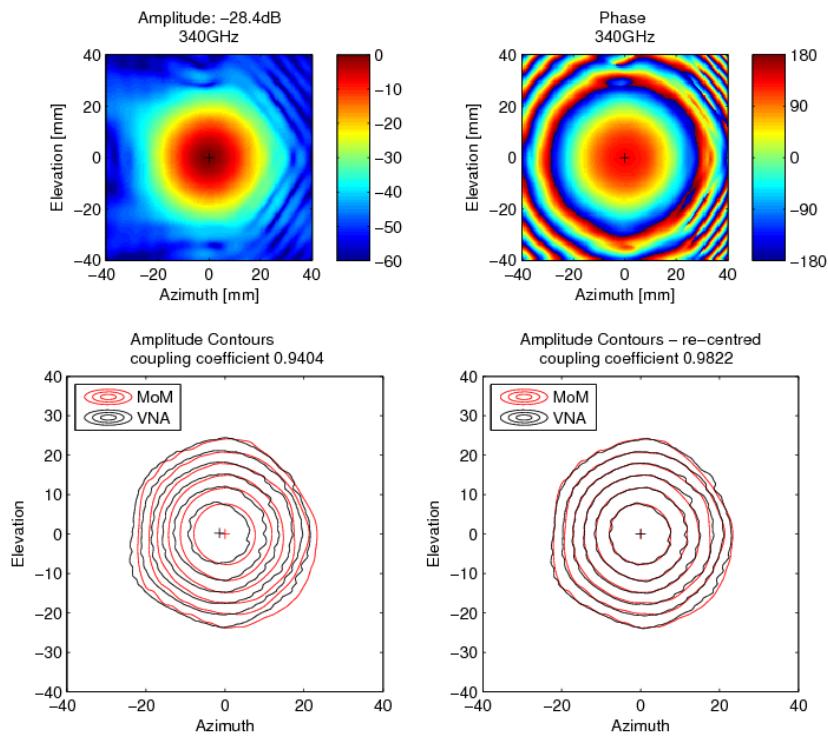

The performance of the STEAM-R focal plane optics has been simulated with GRASP 10 using the Method of Moments add-on. The beam pattern shown above is the result of this simulation at 340 GHz: the contour plots overlay the measured and predicted beam patterns.

3.4 Wire grid polarisers

QMCI and TK manufacture tungsten and gold-plated tungsten wire grid polarisers for frequencies up to 3 THz using a computer-controlled grid-winding machine. Wire diameters as fine as 5 μm , with 10 μm separation, are necessary at the higher frequencies. Grids can be wound on any shape of frame, and dimensions up to 500 mm are currently possible. These have been flown on a wide range of missions including the JPL MIRO instrument, now heading for Jupiter on the Rosetta mission.

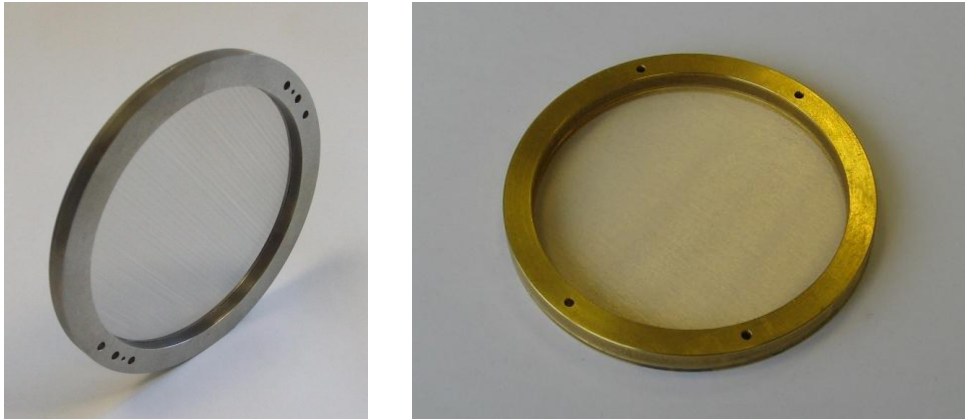

Wire grid polarisers with bare tungsten and gold plated wire



One of a pair of large wire grid polarisers, each using more than 3 km of wire.

The grids can operate at ambient and cryogenic temperatures.

3.5 Dichroics

QMC Instruments use a multi-mesh filter technology that allows extremely precise wavelength selection. Our range of low-pass, high-pass, band-pass and band-stop (notch) filters are now a cornerstone technology used in all major sub-millimetre and terahertz astronomical projects on the ground and in space.

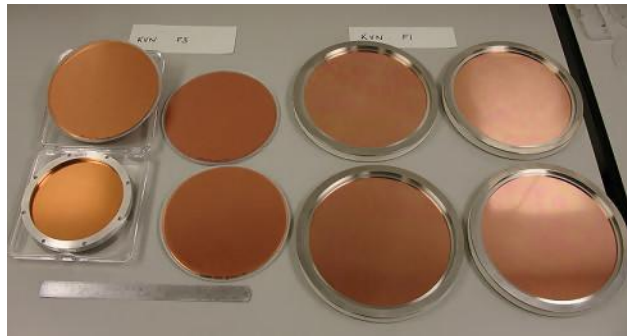

Both standard and custom-designed filters are produced, and are available in any shape and in any size from 6 to 300 mm. The standard filters have high in-band transmission efficiency: 90% transmission in a typical low-pass filter and 80% peak transmission efficiency in band-pass filters. They have low absorption and scatter high broadband out-of-band blocking, and have negligible polarisation sensitivity in transmission (at near normal incidence). The operation temperature range is from ambient to temperatures below 1 K, and the operating-frequency range is from 30 GHz to more than 20 THz.

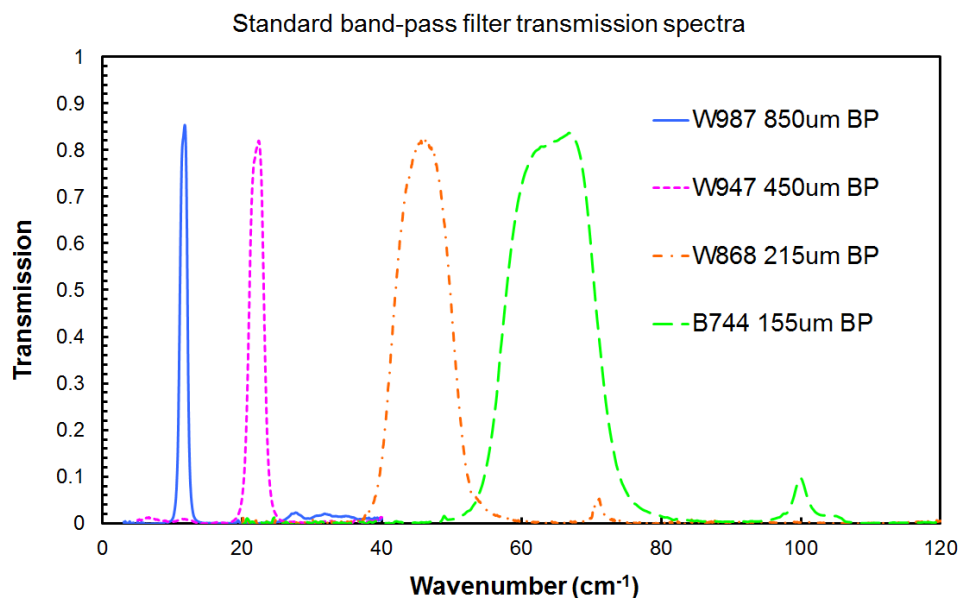

The above figure shows the measured characteristics of the standard band-pass filters. The blue line (850 μm) is for the 350 GHz filter with 10 % bandwidth.

3.6 Absorbers and calibrated thermal targets

Radiometer targets

We have extensive experience of the design, manufacturing and testing of mm-wave radiometer targets, as illustrated in the montage below.

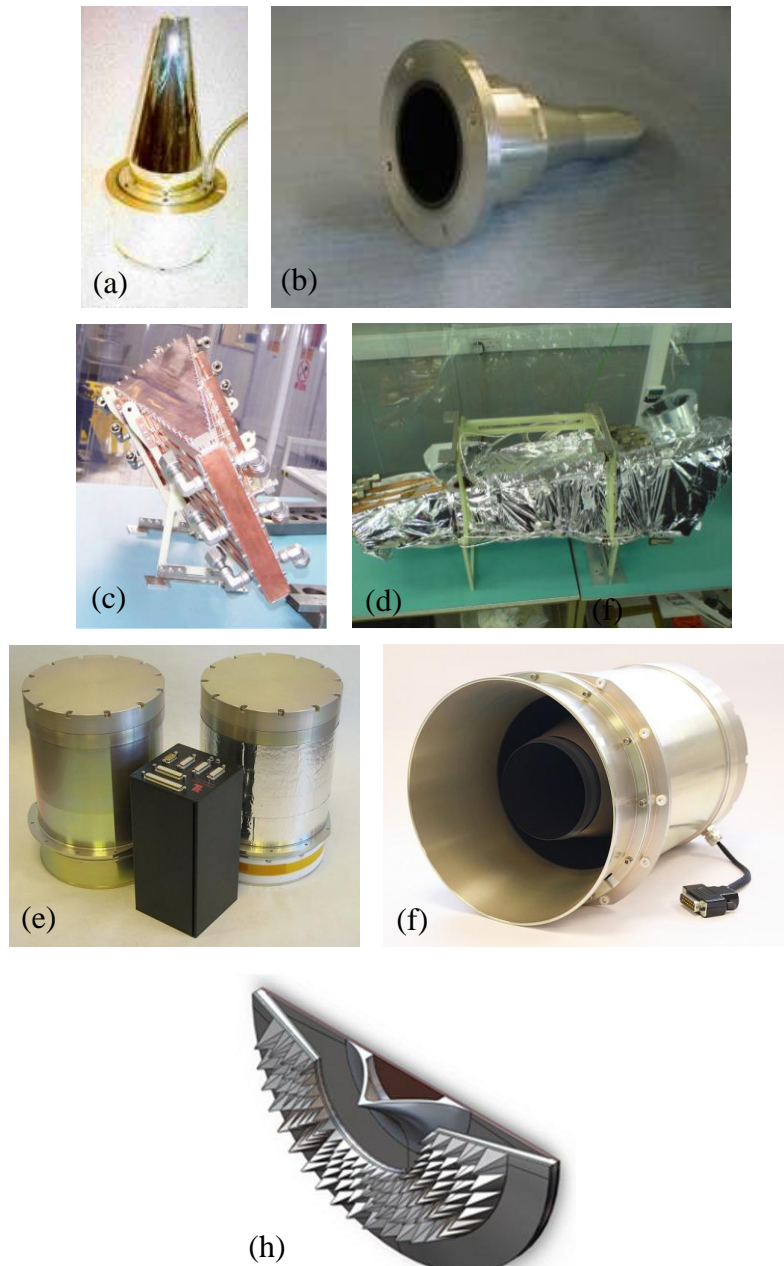

(a) The Calibrated Hot Load (CHL). (b) TELIS calibration target. (c) and (d) Sentinel 3 MWR ground-based calibration targets. (e) and (f) ALMA hot and ambient targets with a controller. (g) cross-section of the Low Mass Calibration Load (LMCL). (h) 3D CAD model of the Low Mass Calibration Load (LMCL).

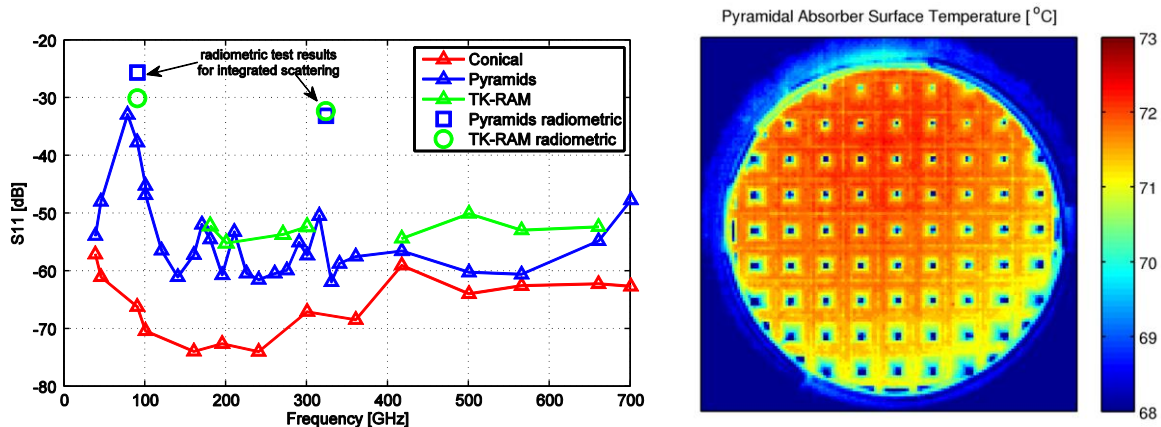

Above are examples of hot load analyses: (left) S_{11} measurements of a metal-backed pyramidal absorber (the initial ALMA prototype) compared to TK-RAM and a conical target design, (right) infra-red image of a pyramidal array for a hot target, showing the cooler tips of the pyramids – conic targets exhibit better homogeneity.

Pyramidal-array absorbers

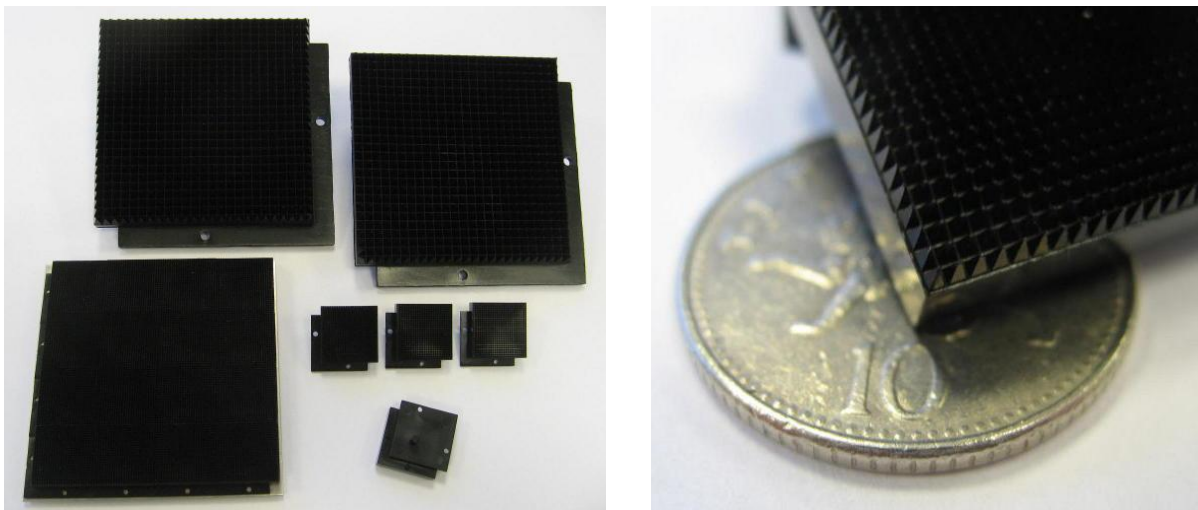

TK manufacture Tessellating TeraHertz Radar-Absorbing Material (RAM) tiles (pictured above). These are space qualified, are suitable for cryogenic operation, have very low monostatic scattering reflection and have low specular reflection. The photograph on the left shows examples of the Large 100 ×100 mm tiles for > 50 GHz, and Small 25 ×25 mm tiles for > 100 GHz. Both can be used to beyond 1000 GHz. Shown on the right is a close-up of a Small tile.

Conic absorbers



Shown above is the HiPER quasi-optic-based electron paramagnetic resonance spectrometer at the University of St Andrews, UK. The quasi-optics were manufactured by TK. More than 20 absorber cones are visible (160 mm O.D.). These are very high performance loads that are being used to reduce standing wave intensity generated by the pulsed 94 GHz beam, which reduces the spectrometer dead time to 1 ns.

3.7 OMTs and diplexers

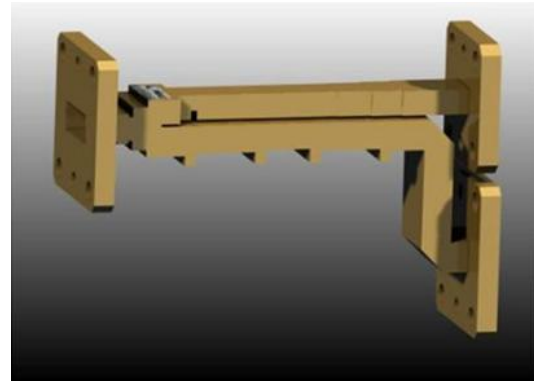
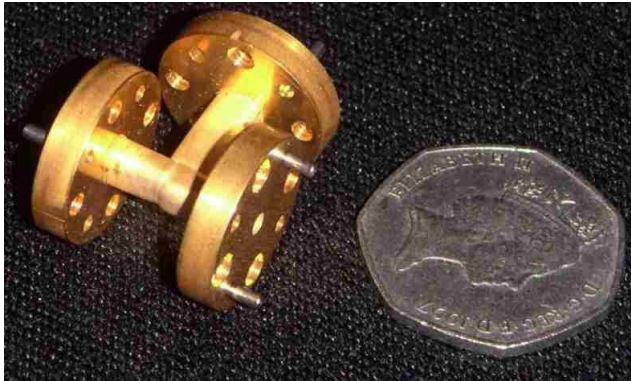

Left: a 94 GHz waveguide OMT manufactured by TK. Right: image of a 23.8/31.4 GHz diplexer.

Very high precision machining processes are needed to achieve the tolerances required for the manufacture of high-performance OMTs and diplexers at high microwave frequencies (e.g. $\pm 4 \mu\text{m}$). We can achieve these using in house sink and wire erosion machines (from AGIE in Switzerland set in our temperature controlled areas) and Moore Jig Grinders.

The VNA measurements of the OMT plus polariser plus corrugated horn – illustrated below – show isolation between the two output ports of more than 40 dB and return losses of better than 25 dB. The frequency range is 93.5 to 95.5 GHz (this OMT would work over a wider band, but as the bandwidth is increased, performance would suffer a little).

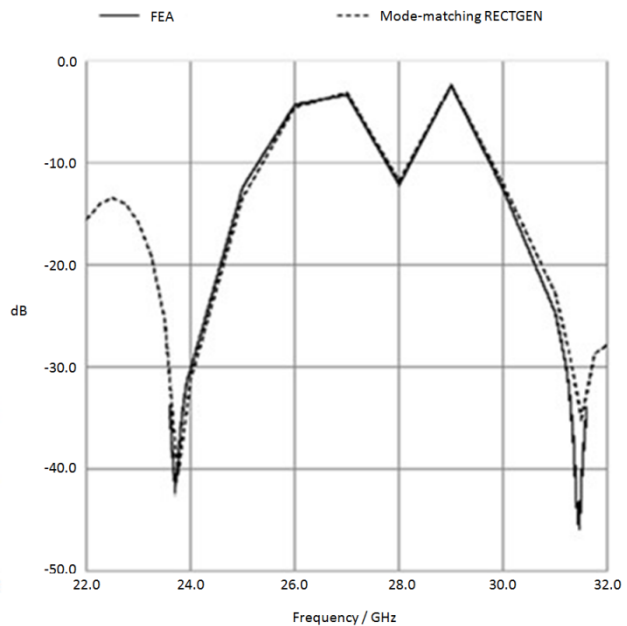
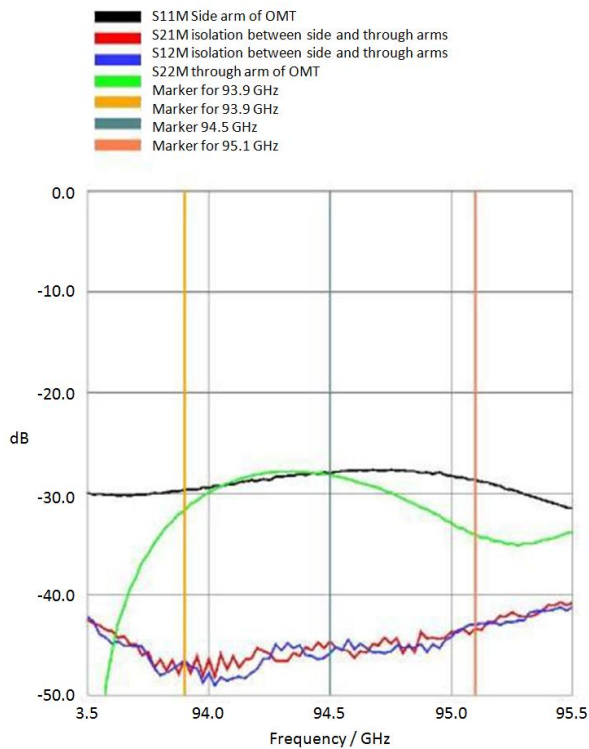

Left: VNA measurements of an OMT – polariser – corrugated-horn chain. Right: analysis of performance for the above 23.8/31.4 GHz diplexer.

4 Subcontractors

Measurement facilities are required to perform the Sxx and antenna pattern measurements on the subsystem components. We regularly use two facilities to make these extensive measurements: the National Physical Laboratory (NPL) in Teddington, London, and the Institute of Applied Physics (IAP) at the University of Bern. The VNA's used to measure Sxx measurements are calibrated to 0.05 dB and 0.5°. The antenna pattern measurements will be made to 0.2 dB accuracy.

Thermometry and electronics for black-body calibration targets have been manufactured with ABSL in Culham, UK.

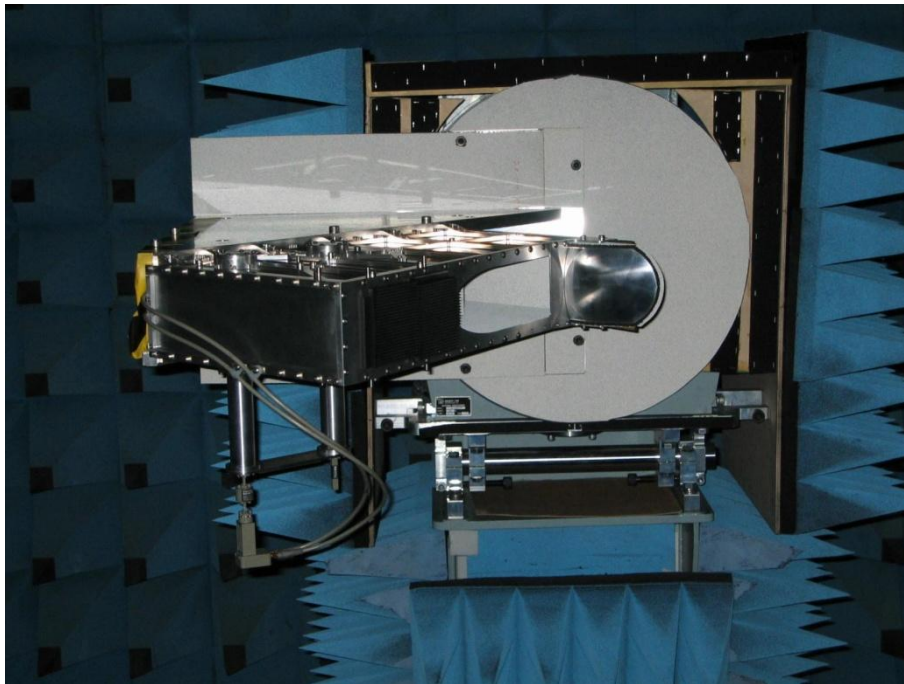

TKs CPR 94 GHz Feed Breadboard for EarthCARE under test at NPL.

5 Facilities

Thomas Keating Ltd.

We have a fully integrated structure optimised for the production of feed horns, from CORRUG and HFSS modelling software, to Pro/Engineer CAD systems and onto CAM software, linked to CNC lathes and in-house electroforming.



Clockwise from top-left: Thomas Keating Ltd. in West Sussex, Brown and Sharpe co-ordinate measuring machine in a temperature-controlled area, HURON high-speed milling machine and DMG Gildemeister lathe with a number of ALMA primary absorber structures.

Facilities at Thomas Keating Ltd's main site in Billingshurst, West Sussex (40 km south of London) include:

- Large range of CNC machinery: milling, turning, jig grinding, wire and sink erosion, operating to 3 μm tolerance
- In-house space-qualified electroforming facilities
- Qualified plating baths
- Brown and Sharpe co-ordinate measuring machine (5 μm)
- Extensive software capabilities:
 - Ansys HFSS (with a high-performance workstation) – EM simulation of feed horns structures on a 12 core workstation with 192 GB of RAM
 - Pro/ENGINEER with TK Gaussian Beam Mode 3D Engine – CAD
 - Edgecam – CAM
 - PC-DMIS – CAD to CMM analysis

For more than 20 years we have maintained ISO 9000:2008 Part 1 status.